

Varenummer: 0106050
 Beskrivelse: Seeger låsering JV 33

Mål

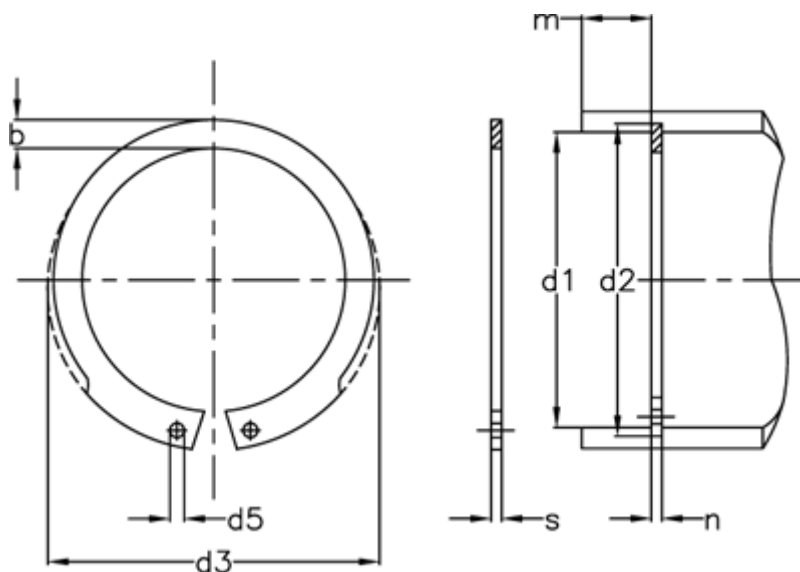

AN mm ²	= 44	FRg kN	= 4.8	Tang	= ZGJ-1
b	= 3.3	FR kN	= 13.8	tol	= -0.06
Betegnelse	= JV 33	g	= 1.0	tol	= +0,50-0,25
d1	= 33	K kN-mm	= 26.6	tol	= +0,25
d2	= 34.7	m min	= 1.30	tol	= 0.1
d3	= 35.5	Nominel træk	= 3.0	vægt kg/1000	= 2.35
d5 min	= 1.5	s	= 1.20		
FN kN	= 7.30	t	= 0.85		